

INSTRUCTION MANUAL

GB



Model No. PCMH45-DW

Congratulations!

We thank you for choosing our PCMH45-DW Humidifier. This equipment has been designed to bring you comfort with an optimum of energy saving for a long period of time

Please read this instruction manual before operating and keep safe for future reference

Get to know your unit.

Read this guide carefully and note all recommended safety precautions prior to operating and to keep your humidifier in good working condition.

Retain this user guide for future reference.

IMPORTANT SAFETY INSTRUCTIONS

WARNING:

When using electrical appliances, basic safety precautions should always be followed:

1. a). This product is intended for indoor use ONLY and not for outdoor use. Do not place the appliance too close to curtains or other objects that are sensible for humid air.
b). Always empty the water tank before storing the appliance away.
2. Extreme care should be taken when any product is used by, or near children, and whenever the product is left operating and unattended.
3. Before operating the product, remove the unit from its packaging and check it is in good condition.
4. **DO NOT** let children play with the packaging, for example plastic bags, as there is a danger of suffocation. Children should be supervised to ensure that they do not play with the appliance.
5. **DO NOT** operate any product with a damaged cord or plug. If the supply cord is damaged, it must be replaced by the Manufacturer or an authorized service centre in order to avoid a hazard.
6. This appliance is not intended for use by persons (including children) with reduced physical, sensory or mental capabilities, or lack of experience and knowledge, unless they have been given supervision or instruction concerning use of the appliance by a person responsible for their safety. People who have not read this manual or are not used to this kind of product should not be allowed to use the unit.
7. **DO NOT** attempt to repair or adjust any electrical or mechanical functions on this unit, as this may void warranty. Take the unit to a qualified service engineer for inspection and repair.
8. Check the household voltage to ensure it matches the unit's rating plate specification before operating.
9. Only use in the upright position on a flat level surface.
10. **DO NOT** cover, or block any of the air outlets and/or air inlets.
11. Always unplug the appliance from the power source before servicing or removing the unit.
12. Always unplug the product when not in use. To disconnect from the power supply, grip the plug and pull from the power socket. Never pull by the cord.
13. **DO NOT** run power cord under carpeting, or cover with rugs or runners.
14. Arrange the cord away from areas where it may be tripped over.
15. Avoid the use of an extension cable as this may overheat and cause a fire.
16. **DO NOT** insert or allow objects to enter any ventilation or exhaust opening as this may damage the product and could cause an electrical shock or fire.
17. **DO NOT** use the product in areas where petrol, paint, or other flammable goods and objects are present.

FOR THE U.K. ONLY

BS PLUG WIRING

Wiring Instructions: Should it be necessary to change the plug please note the wires in the mains lead are coloured in accordance with the following code:

- BLUE – NEUTRAL
- BROWN – LIVE
- GREEN AND YELLOW - EARTH

As the colours of the wires in the mains lead of this appliance may not correspond with the coloured markings identifying the terminals in your plug, proceed as follows:

1. The **BLUE** wire is the **NEUTRAL** and must be connected to the terminal, which is marked with the letter **N** or coloured **BLACK**.
2. The **BROWN** wire is the **LIVE** and must be connected to the terminal, which is marked with the letter **L** or coloured **RED**.
3. The **GREEN/YELLOW** is the **EARTH** and must be connected to the terminal which is marked with the letter **E** or  or coloured **GREEN OR GREEN/YELLOW**.
4. Always ensure that the cord grip is positioned and fastened correctly.

If a **13A (BS 1363)** fused plug is used it must be fitted with a **5A** fuse. If in doubt consult a qualified electrician.

Wiring for a 13Amp Plug (BS1363)

Please note. The Earth Terminal is marked with the letter **E** or  Symbol

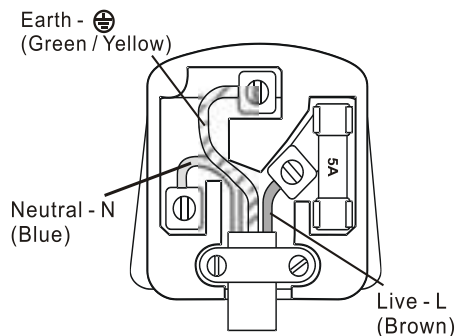

Schuko to UK converter plug

This Schuko to UK converter plug is used in this product. Refer to UK plug wiring instruction section for regular UK plug wiring.



PREPARATION BEFORE USE

Unpacking your humidifier:

- **Unpack the unit from the packaging.**
- **Remove the adhesive tape, unlock the top cover with a small coin and take out all the transit packaging materials from inside the unit.**
- **Completely unravel the power cord, so as not to damage it.**

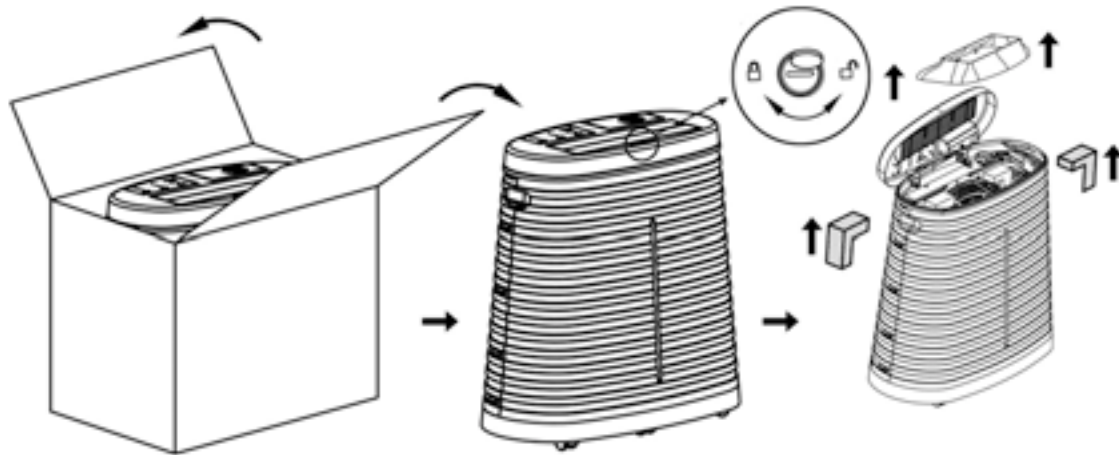

Locating your humidifier:

For best results we recommend you locate your unit in the middle of a room. Do not place the humidifier near furniture, paintings or any other object which could suffer damage from the moisture

Connecting to power supply:

Before using the humidifier, extend the cord completely and inspect for any signs of damage.

Plug the unit into the power socket (230Volt-50 Hz 10Amps).

Humidifier consumption does not exceed 0.5 Amps (110Wh)

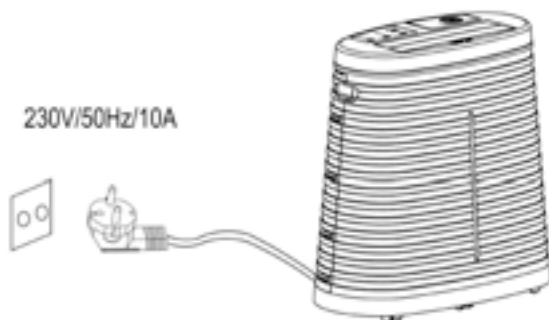

HOW IT WORKS

This large humidifier is designed to increase the room humidity up to a specified level. Two major systems are employed:

1. Air flow system, which uses an asynchronous motor and axial flow fan to drive the air through the evaporative pads and blow a certain amount of humid air into the room.
2. Water wheel, which holds the evaporative pads onto the drum, which is driven by a synchronous motor and gear mechanism. The pads deliver water from the water tank through the drum rotation and the fan removes certain moisture from the sponge by the principle of evaporation.

IMPORTANT : Before switching on the unit, ensure that the water wheel snaps into the bearings at both ends correctly, to ensure the correct movement of the water wheel

FILLING THE WATER

1. Lift up the water inlet cover. Fill the water into the tank through the water inlet tube (Figure.1). Once the water reaches the max level, there will be a 10sec audible alarm and the green light will illuminate. When you fill the water with the unit unplugged from the electric socket, please check the "MAX" water level indicator through the overflow connector cap located at the tank. You can also fill water directly into the tank by removing the tank as follows:

- 1) Unlock/open the top cover and remove the water wheel
- 2) Unlock the tank, and slide it out (Figure.2).



Figure.1

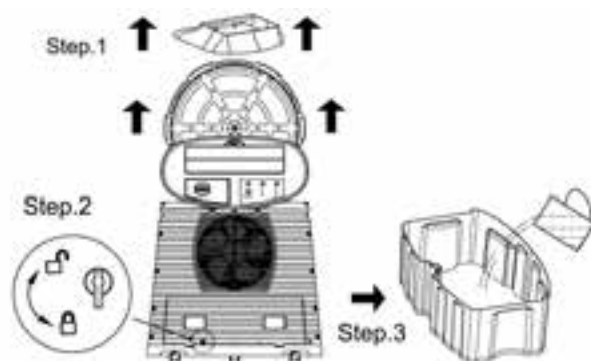

Figure.2

IMPORTANT:

- in order to avoid the risk of electric shock, unplug the appliance during filling and cleaning, and take care not to spill water on the control panel and wiring inside the unit.

2. DIRECT WATER CONNECTION INSTRUCTION

Using a direct water connector is convenient for continuous supply of water to your humidifier. The tank has a built-in float and valve system to control the water supply. Before use please read these instructions carefully.

Please connect the hose tightly onto the connector at the back of the tank using a 25.4mm female screw nut. Connect the other end of the hose to your water tap.

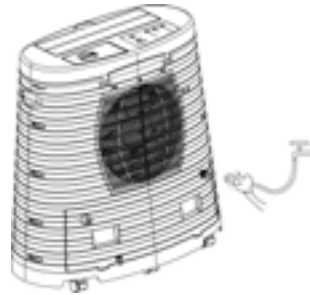

NOTE:

The tank is equipped with an overflow protection. In the unlikely event of malfunction with the float valve system, the excess water can be discharged through the overflow connector.

The transparent cap with “MAX” water level mark can display the water level when the water is being filled manually.



Direct water connector accessory

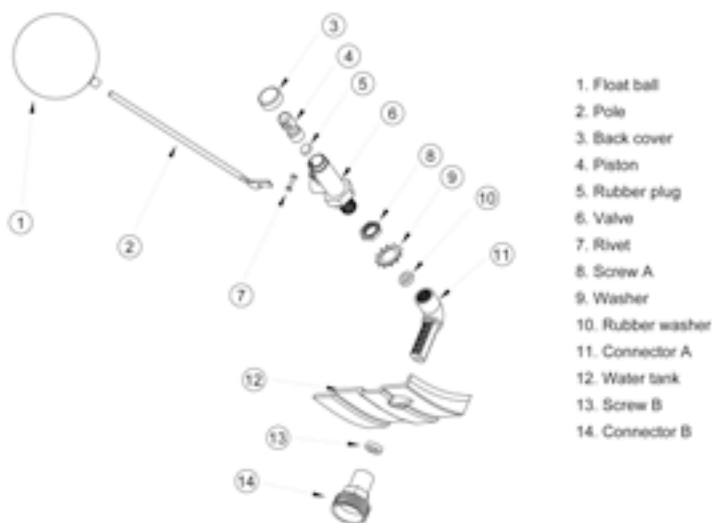

SPECIFICATION

Power	220-240V~50Hz
Power consumption	70Watts
Air Flow	500m3/h
Evaporating Capacity	45 L/24h (at 21°C x 30% RH)
Fan Speed	3-Speeds(Hi/Med/Lo)
Tank Capacity	30L
Approvals	CE&GS
Product Dimensions (H*D*W)	750*440*745(mm)
Shipping Dimensions(H*D*W)	780*455*795(mm)
Net Weight	12.4Kg
Gross Weight	17Kg

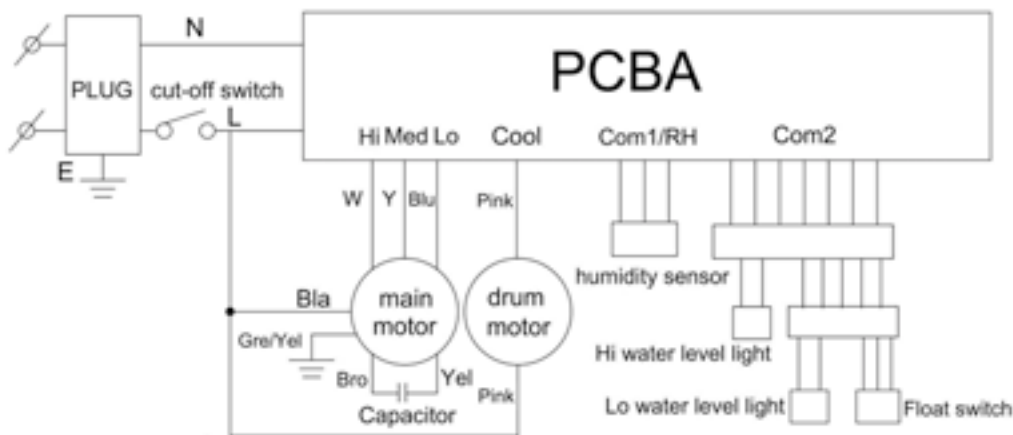

WIRING DIAGRAM

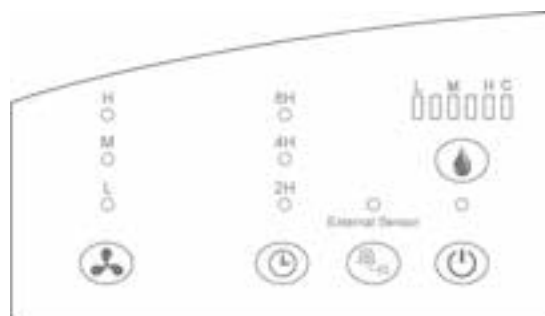

Wiring diagram

OPERATION & FEATURES





1. Plug the power cord into a properly grounded 220~240Volt AC outlet. The power indicator will illuminate.
2. To turn the unit on, press the  button, the unit will run in the default setting (low fan speed and continuous humidity).
3. Use the  button to alter the fan speed between High, Medium and Low. The indicator will show the setting you have selected. The high fan speed will result in quicker humidity increase.

4. Press the  button to choose a desirable humidity setting. The indicator will show the setting you have selected. In order to keep the room at the selected level of humidity/comfort the unit will cycle ON and OFF.

NOTE:

- **L (low) the unit will keep the humidity level around the 30% RH**
- **Between L and M unit will keep the humidity level around the 40% RH**
- **M (medium) the unit will keep the humidity level around the 50% RH**
- **Between M and H unit will keep the humidity level around the 60% RH**
- **H (high) the unit will keep the humidity level around the 70% RH**
- **C (continuously) the unit will work continuously**

5. Use the Timer button  to set the unit to automatically switch off in 2, 4 or 8 hours. While the unit is running, you can set the timer to switch the unit off.

6. This product is designed to allow the use of an external humidistat device connected with the power supply cord. If using an external humidistat, press the  button so that the humidity level can be solely set by the external device. The timer also doesn't work in this mode, Only the Fan speed can be altered between High, medium and Low.

7. Top cover is equipped with a child lock. Please use a small coin or flat head screwdriver to unlock it. When the cover is opened for servicing or removing the water wheel, the power will be cut-off automatically to avoid any electrical shock/injury.

8. When the water level drops to the Min level, there will be a 10sec audible alarm and the red light will illuminate and keep flashing. You can only reset it by re-filling water into the tank.

9. This humidifier has a memory function. When the unit is routinely turned off without any power interruption, the previous Fan & Humidity settings will become the default settings when the unit is switched on the next time. This is often referred to as auto restart after power cut.

10. The unit has 6 casters of which two are lockable. These two casters are at the left and right of rear side of the unit. We strongly recommend when the unit is in operation these two casters are locked by pushing down the lock lever.

IMPORTANT:

- **once the room humidity is higher than the set parameter, the unit will not turn on**
- **Move the unit gently and very carefully when it is filled with water in order to avoid water splashing onto the floor or internal electrical parts.**
- **When restarting the unit or opening and re-placing the top cover, TANK FULL and TANK EMPTY sensors will re-detect the water level, and give the signals accordingly.**

CARE AND CLEANING

Frequent cleaning is necessary to maximize and extend the life of your humidifier.

Always disconnect the unit from the wall socket before cleaning and maintenance.

1. Evaporative Pads

The humidifier evaporative pads have several functions. They are the most important parts of your humidifier since they perform the following functions:

- **Moisture Evaporation**
- **Air cleaning**

It is essential to keep the pads clean and replace them **periodically (at least yearly, but preferably twice a year)** depending on the amount of use, water hardness, local air pollution. To replace the pads, open the humidifier top cap (figure.3), Take out the air flow direction part (figure.4)., Remove the wheel carefully (figure.5). Open the clip holding the round foam-pad(figure.6).Remove the circular foam-disk, and clean the foam pads with white vinegar or de-scaling agent or replace with new ones if too old (figure.7). Relocate in original position. Fix foam pads in correct position with clip. Do the same with the foam-pad that sits around the wheel.

Please order replacement evaporative filter set (2 piece evaporation media and 1 carbon dust filter) Article number: EFS-PCMH45

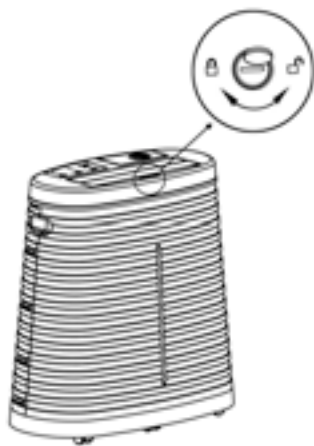

Figure.3



Figure.4

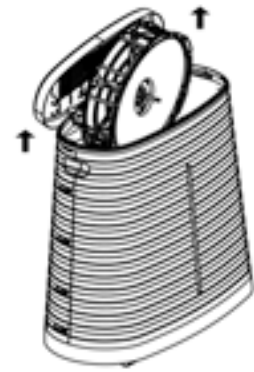

Figure.5

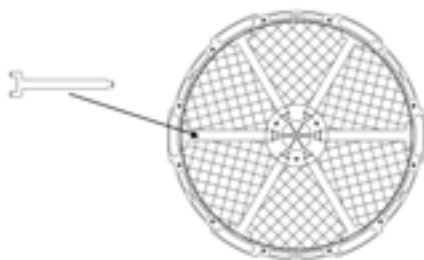

Figure.6



Figure.7

2. Water Reservoir

Open the humidifier top cap, Remove the airflow direction part, Remove the wheel, carefully Unlock and slide back the water reservoir. Clean all remaining scale with a scouring pad. Relocate water reservoir by smoothly sliding it back till the water reservoir is in the correct position and locked.

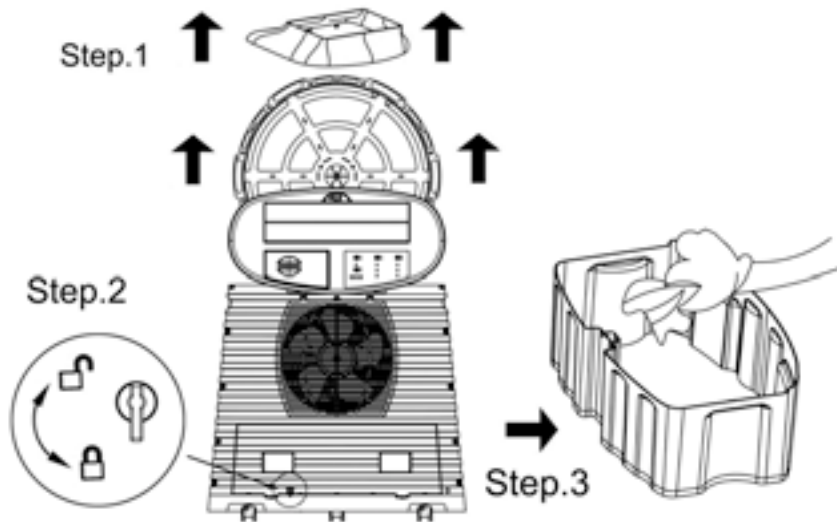

3. Filter

Remove the filter protection guard by un-screwing the small screw. Remove the dust filter and clean this by using a vacuum cleaner and rinse in warm water. Before replacing ensure that the dust filter is fully dry. Replace the dust filter and replace the filter protection guard and fix with the screw.

We recommend that the dust-filter is replaced at least once a year.

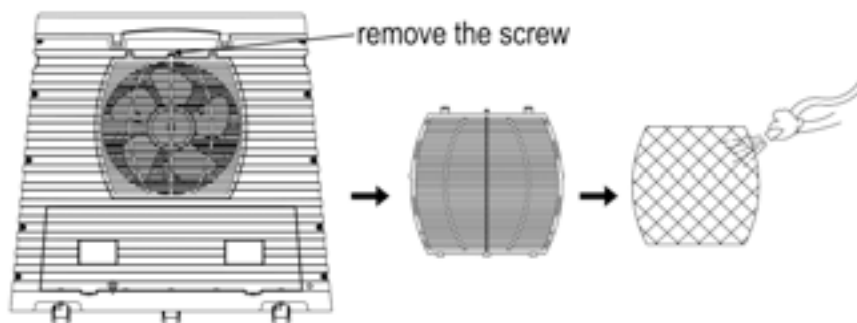

4. Cleaning inside and outside

Use a soft cloth with mild soap to clean the outside and other inside parts with possible scale deposits on your humidifier. Never use aggressive detergents to clean the unit. In order to extend the lifetime of your humidifier we recommend that you regularly clean the unit inside, outside and the water reservoir.

WARRANTY:

- Do not operate the unit with a damaged cord or plug, after the unit malfunctions, has been dropped or damaged.
- For your convenience, record the complete model number and product name (located on the Product Identification Plate), the date you purchased the product, and attach your purchase receipt as proof of purchase.
- To ensure your product is covered by warranty, the complete faulty product together with your purchase receipt should be returned to your retailer.

Please contact your retailers regarding warranty information

This product has been manufactured to comply with EEC Directives 2006/95/EG and 89/336/EEC



Waste electrical products should not be disposed of with household waste. Please recycle where facilities exist. Check with your Local Authority or retailer for recycling advice.

